



[CTW100]

TWO WAY RADIO TRANSPONDER

USER'S OPERATING MANUAL

Released Version: V.1.0
Released Date: 2010. 03. 12.

SRC Co.,Ltd.

65-23, 2Ga, Namhang-dong, Youngdo-Gu, Busan, Korea
TEL) 051 - 417 - 5807 FAX) 051 - 412 - 6197

HOME PAGE : www.oksrc.com

RECOMMENDATIONS AND SAFETY NOTICES

※(To use safely)

Please, read this manual before operation.

※ This Radio Equipment has been designed for convenient use for many purposes but care should be taken to avoid wiretapping by another person. Therefore, you should keep in mind that the conversation concerning national secrets, industrial information as well as privacy can be heard by another person.

※ Herein, the following notes describe important information to which you have to pay attention.

- ▲ If not treated properly, the faulty situation is expected.
- ▲ Don't charge Primary-Battery.
- ▲ Don't take off the seal attached on primary battery. If the seal is removed, it would be assumed as valid date has expired.
- ▲ Don't expose battery close to the fire. There is a danger of an explosion.
- ▲ Don't expose battery to the temperature more than +70°C. There is a danger of an explosion.
- ▲ Don't expose battery to the temperature less than -30°C. It can be discharged.
- ▲ Don't touch Battery with wet materials.
- ▲ Don't make the battery to be short-circuit.
- ▲ When use the jack for earphone, it should be tighten by the screw bolt or it can't be watertight.
- ▲ This equipment is designed to be watertight. If it is disassembled at your discretion, it can't be watertight and not guaranteed also.

INDEX

I . INTRODUCTION.....	5
1.1 Overview.....	5
1.2 Feature	5
1.3 Composition	6
1.4 Specification	7
II . CONTROLS INSTRUCTION.....	8
2.1 Description of each Component.....	8
2.2 Display on LCD Panel.....	11
III. GENERAL OPERATION	12
3.1 Power ON/OFF	12
3.2 Channel Selection	12
3.3 Squelch Level Adjustment.....	13
3.4 TX power level Selection.....	14
3.5 Transmition	14
3.6 Reception.....	15

3.7 Receiving Function Check 15

3.8 Volume Level Adjustment 15

IV. SETUP FOR OPTIONAL FUNCTIONS 17

4.1 TX Power Level 17

4.2 KEY Locking 18

4.3 Battery Save Mode 19

4.4 Dual Watch 20

4.5 Beep Establishment 21

4.6 Squelch Level 23

4.7 Location Indication 23

V. MAINTENACE 25

VI. SECONTARY BATTERY & CHARGER 27

6.1 Secondary Battery 27

6.2 Charger 27

I . INTRODUCTION

1.1 OVERVIEW

CTW100 is a two-way radiotelephone for use on-board and on-scene communication that is one of equipment consisted in the GMDSS. This uses 19 simplex channels which are VHF frequency assigned to international maritime mobile service.

Frequency rate of those channels is 156.300MHz ~ 156.875MHz. Ch15(156.750MHz) and Ch17(156.850MHz)are districted under 1W of radiated power followed by Radio Regulations - S.18. Ch70, used for exclusive digital selected call for distress, Ch87(AIS 1), Ch88(AIS 2) of global Automatic Identification System, and districted Ch75 and Ch76 for maritime use are excluded of using frequency on CTW100.

CTW100 is designed to comply with IMO(International Maritime Organization) Resolution - A.694(17), A.762(18)and A.809(19). It is also comply with Korean radio equipment standard, maritime radio navigation and equipment technical stand, and type approval and registration.

1.2 FEATURE

(1) Using of the synthesizer controlled by microcomputer enables the higher frequency stability maintained at any channel and a currently programmed frequency can be modified to different one by simply programming.

(2) External MIC/Speaker can be attached.

The hook on the rear of the equipment also makes flexible to use it free fixing at a convenient place.

(3) Both of primary and secondary batteries were designed to be mounted and separated easily.

(4) All of active devices have a long life cycle and robust characteristics under various environment conditions at the expense of employing semiconductors and special ICs.

(5) Small lightweight and easy-to-use structure makes the Equipment capable of being brought and operated easily by unskilled personal, even wearing gloves.

(6) The equipment is watertight to a depth of 1 m for at least 5 min and not unduly affected by seawater or oil.

(7) Basic color of the equipment is a clearly visible yellow color identified easily, even at a dark place.

(8) A primary battery have sufficient capacity to ensure 8 hours operation at its highest rated power with a duty cycle of 1:9 and a shelf life of at least 3 years.

1.3 COMPOSITION

Basic equipment (CTW100) is composed of the following components:

- (1) Transceiver**
- (2) Antenna**
- (3) Primary Battery(Lithium Battery)**
- (4) Secondary Battery(Ni-Mh Battery)**

(5) Battery Charger(Fast)**(6) Recharge Adapter****(7) Belt Clip****(8) User Manual**

Also Following options can be provided on customer's choice

(1) External Mic/Speaker**(2) Secondary Battery(Ni-Mh Battery)****(3) Bluetooth Dongle****1.4 SPECIFICATION**

Frequency range	156.300 ~ 156.875MHz
Regular Output Power	HIGH - 3.0W / LOW - 0.5W
Radio Wave Type	16KOF3E
Communication Methods	Simplex
Usable Channels	19 Channels
Channel Space	25kHz
Warming Up Time	Within 5 Sec
Supplied Voltage	7.4V(DC)
Operating Time	Over 8 Hour (TX 10%, RX 10%, standby 80%)
Operating Temperature	-20°C~ + 55°C
Water Resistance	contains not less than 5 min at 1m depth
Dimension	51(W)× (33D)× 104(H)mm
Weight	Primary Battery Installed - 250g (Main-body: 163g, Battery: 87g) Secondary Battery Installed - 280g (Main-body : 163g, Battery : 117g)

II . CONTROLS INSTRUCTION

2.1 DESCRIPTION OF EACH COMPONENT

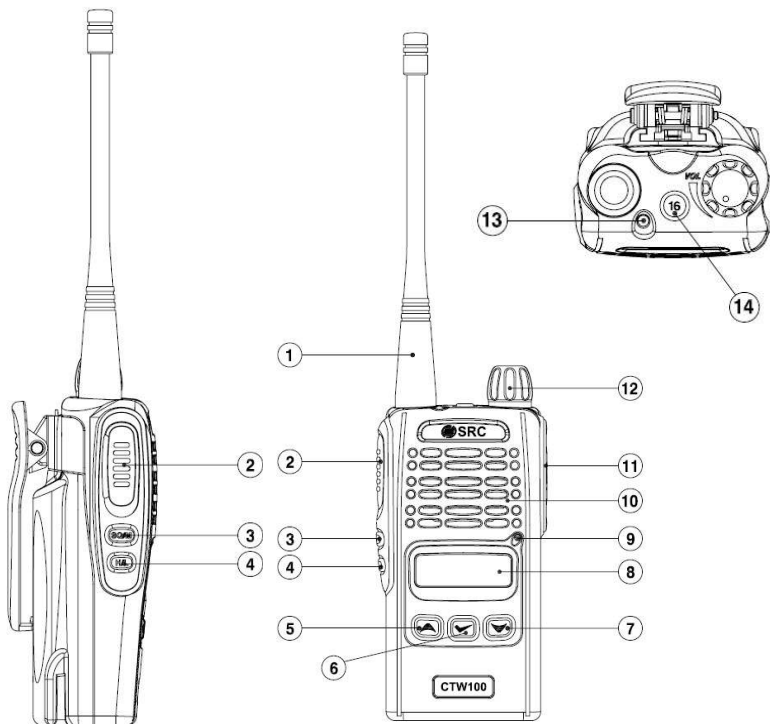

(1) Antenna

Used to emit radio frequency power

(2) PTT Key

For transmitting press the PTT(Press-to-talk) button and then communicate.

(3) SQ LEVEL selection / Receiving Check Key

Used to switch of SQ LEVEL

Used to confirm receiving function to the equipment.

Press and hold this key over 2seconds to monitor an appropriate channel () with beep sound.

To stop the function, press the key once again.

(4) High/Low Key

Used to select an output power level either High(3W) or Low(0.5W).

(5) Up Key

Allow changing current channel upward to select a desired channel number directly.

It also could be used for choosing an alternate establishment from menu.

(6) Enter Key

Permit to enter into optional menu and to ensure a selected channel or established item from menu.

(7) Down Key

Allow changing current channel downward to select a desired channel number directly.

It also could be used for choosing an alternate establishment from menu.

(8) LCD

Indicates channel number, current status of battery, selected function, etc.

(9) Microphone

When transmitting, the microphone shall be positioned at the distance of 5~7cm from your mouth.

(10) Speaker

Located on the upper front of the equipment that has output function of received voice.

(11) External Earphone/MIC and Programming Jack Socket

External EAR/MIC can be connected via this jack.

If this has been connected, internal microphone and speaker are not activated. It is also able to use as charging terminal.

(12) Power on / off and Volume Control Switch

Used as ON/OFF switch. When power had been turned ON, it can be used for adjusting a sound level.

(13) LED

Indicate transmitting/receiving status by red and green color correspondingly.

(14) CHANNEL.16

Press the key to allow changing to Ch.16 instantly.

2.2 DISPLAY ON LCD PANEL



(1) H / L: Transmitting Output Power - H(3 W), L(0.5W)

(2) : Button Lock

(3) : Battery Level Indicator

(4) D.W : Dual Watch Mode

The dual watch mode allows Ch.16 to be received when the other channel is activated. Refer to paragraph 4.1.



(5) : BEEP

(6) : Receiving Status Indicator

III. GENERAL OPERATION

3.1 POWER ON/OFF

(1) Power ON

Turn the knob of power ON/OFF & Volume Control clockwise to switch ON the equipment and  appears in a few seconds on the initial display and then a latest established status including channel number and usable battery capacity will be displayed as .

It will take 1sec from power ON to standby condition.

(2) Save the latest established data



Turn the knob of power ON/OFF & Volume Control counterclockwise to switch the power OFF.

Now, if you switch ON it again latest used channel number, squelch level, output power level and other established menu items will be loaded automatically.







ON/OFF status of Dual Watch Function is also saved.

3.2 CHANNEL SELECTION

To establish the desired channel number use  or  (UP/DOWN) key on the front of the equipment.



☞ Just channels used with simplex from ITU VHF channels assigned for maritime mobile service have been established and only these channel numbers could be selected.



Press and hold on  or  (Up/Down) key to change channel number one by one quickly. Pressing  key via the highest channel number will make a move to the lowest channel number and pressing  key via the lowest channel number will make a move to the highest channel number.





Press  key beside the antenna on the topside of the equipment to establish Ch.16 instantly.

It also could be established through general channel selection.

3.3 SQUELCH LEVEL ADJUSTMENT

Press  key located on the right of the front of equipment. The display will be as  and the squelch level is ready to be adjusted.

☞ If  or  key were not been pressed consequently, the value on the display will be established as a squelch level automatically and then the status of the initial screen will return.

In the status of display as  select a desired squelch level by using  or  key and press  (Enter) key to ensure selected squelch level. Then display will return to initial screen.

☞ Value of squelch level has been established 8 by default.

3.4 TX POWER LEVEL SELECTION

TX power can be selected either High or Low.

If display appears as , it means that TX power is established as H(High).

To change High(2W) power to Low(0.5W) power, press  key on the left of the front of the equipment.

Display becomes as  and it means that TX power is established as L(0.5W).





It is not allow to change Tx power level when the channel hasn't been changed completely by pressing enter key () or after an elapse of 3sec



Channel 15, channel 17 could be set to only L(0.5W)

3.5 TRANSMISSION

To transmit on the current channel in receiving or standby mode, press  (PTT) key on the left side of the equipment and communicate simultaneously by positioning the microphone near to your mouth.

Release  (PTT) key to stop speaking and return to receiving or standby mode.

By pressing  (PTT) key for transmission of a message, Tx/Rx indicator will be lit up with red color on the upper right of the front.



Pressing the PTT switch for a long time causes the battery to be exhausted quickly.

3.6 RECEPTION

To receive communication from other person via current established channel doesn't need to press any key.



If any signal has been detected in standby mode, it will make conversion to receiving mode automatically. Also it will cause TX/RX indicator to be lit up with green color and  mark appears on the display.



Receiving is impossible with PTT key pressing.

3.7 RECEIVING FUNCTION CHECK

This function allows ensuring that the receiving function is activating.

Press  key more than 2 Sec to keep on receiving operating and press  key for a second time to stop receiving operating.

3.8 VOLUME LEVEL ADJUSTMENT

To adjust the volume of receiving sound, turn the knob of power ON/OFF & Volume Control in a desired direction.

Turn it clockwise to raise a receiving sound and turn it counterclockwise to reduce it.





Turning to the maximum in counterclockwise direction will reduce a receiving sound and can make power off.



IV. SETUP FOR OPTIONAL FUNCTIONS



4.1 TX POWER LEVEL

This function has been mentioned already in Paragraph 2.1.4  and in Paragraph 3.4 "Selecting TX power level".



The transmitting power level can be established in the optional menu mode also.



First of all, ensure which power level has been established in the receiving or standby mode. The High is displayed as  and the Low is displayed as .

To change current power level, press  (Enter) key to enter into the optional menu mode. The display appears to be as .

If not press  or  key within 3 seconds consequently in the above status until the display becomes as .

Press  (Enter) key in the above status to enable transmitting power level to be changed.

If the High(2W) has been established, the display will indicate as  and if the Low(0.5W) has been established, the display will indicate as .

To choose an alternate power level, press  or  key and then press  (Enter) key to enable a desired power level to be displayed.



It is not allowed to change Tx power level when the channel hasn't been changed completely by pressing enter key() or after an elapse of 3sec.



Channel 15, channel 17 could be set to only L(0.5W)



4.2 KEY LOCKING

This function is used to prevent an inadvertent establishment resulting from carelessness or mistake of operator.



If this function is established, all keys excluding the PTT switch, Receiving Check key and the  key on the topside of the equipment couldn't be activated.





A lock mark  " " on the  indicates that the key locking has been established

To activate or release the key locking, press  (Enter) key to enter into optional menu mode..

Press  or  key several times so the display would indicate as .

 If no key is pressed consequently in above status, it escapes from the optional menu mode and return to initial screen.

If it is displayed as , press  (Enter) key to activate or release the key locking.

If the key locking function has been released and the initial screen was without a lock mark "", the display indicates as , and to activate key locking, press  or  key within 3sec consequently to choose the ON status.

Press  (Enter) key within 3sec consequently to ensure the ON status is displaying.

To release the key locking, the  (Enter) key should be pressed more than 2sec.





Even if key locking has been established, PTT switch, Receiving Check key and CH.16 key are activated.

4.3 BATTERY SAVE MODE





This function enables to extend the usable time of the battery resulting by decreasing the power consumption in unnecessary devices. The establishment of the function permits to carry out minimized activities in operating equipment so that it could manage the required power for each built-in device effectively.

To establish the economy battery mode, press  (Enter) key to enter into the optional menu mode.

Press  or  key within 3 seconds consequently in the above status until the display will indicate as .

Press  (Enter) key again within 3sec consequently in the above status to ensure the current status as "On" or "Off"

If it hasn't been established for the economy battery mode, the display will indicate as .



To establish the economy battery mode, press  or  key to choose the display status as  and then press  (Enter) key to ensure it.







battery save mode has been set to OFF by default.

4.4 DUAL WATCH





This function allows the receiving Ch.16 emergency channel together with currently using channel simultaneously. If it is displayed as , the DW mark on the screen means that dual watch function has been established.

Press  (Enter) key to enter into optional menu mode. The display appears to be as .



 **If no other key is pressed consequently in above status, it escapes from the optional menu mode and returns to initial screen.**

Press  or  key within 3 seconds consequently when display is in a status as  until it turns to be as .

 If no key is pressed in this status also, it escapes from dual watch establishment mode and returns to initial screen.

Press  (Enter) key within 3sec consequently in the status of display as  and then the display appears to be either  or .

 If no key is pressed in this status also, it escapes from dual watch establishment mode and returns to initial screen.

현재 설정된 ON 또는 OFF 를 변경하기 위해서는 다시 ,  (UP/DOWN)버튼을 눌러 원하는 상태가 LCD 상에 표시되도록 설정하고  (ENTER KEY)버튼을 누른다.

 If DW mark was indicated on the initial screen, now it is absent by ensuring the OFF status.

 If the initial screen was indicated without DW mark, now it is indicated with DW mark ensuring the ON status.



Dual watch mode has been set to OFF by default.

4.5 BEEP ESTABLISHMENT



This function is established to generate or mute audible tone such as "Pi-" sound when any key except the PTT switch is pressed.

The bell mark " " on the LCD  indicates that the beep has been established.



First of all, Press  (Enter) key to enter into optional menu mode.

Preferentially, the initial screen in optional menu mode would indicate as



Otherwise, press  or  key several times so the display would indicate as .

 **If no key is pressed in this status, it escapes from the optional menu mode and returns to initial screen.**



To continue, press  (Enter) key within 3sec consequently in the status of display as .

If the beep has been established already, the display appears as .

If the beep hasn't been established, the bell mark " " doesn't indicated on the upper middle of the initial screen and the display appears as



 **If no key is pressed in this status also, it escapes from the beep establishment mode and returns to initial screen.**

Press  or  key to choose ON or OFF status and press  (Enter) key within 3sec consequently to ensure a desired status is displaying.







Beep mode has been set to ON by default.



4.6 SQUELCH LEVEL



This function has been mentioned already in Paragraph 3.3-"Squelch Level Adjustment".

The squelch level can be established in the optional menu mode also.

To adjust the squelch level, press  (Enter) key to enter into the optional menu mode. The display will indicate as .

Press  or  key within 3 seconds consequently in the above status until the display will indicate as .

Press  (Enter) key within 3 seconds consequently to display an established squelch level currently as .

Select a desired squelch level by using  or  key and then press  (Enter) key within 3 seconds consequently to ensure the selected squelch level. Then display will return to initial screen.



Value of Squelch Level has been set to 4 by default.

4.7 LOCATION INDICATION





This function is to find the position of the equipment easily. If this function has been established, the LED for Tx/Rx indication would be blinked every 15sec with green color to ensure the position of the equipment in the darkness.

To establish the position indication mode, press  (Enter) key to enter into the optional menu mode.

Press  or  key within 3 seconds consequently in the above status until the display will indicate as .

Press  (Enter) key again within 3sec consequently in the above status to ensure the current status as “ON” or “OFF”.

If it hasn't been established for the position indication mode, the display will indicate as .

To establish the position indication mode, press  or  key to indicate as  and then press  (Enter) key to ensure it.



Position indication mode has been set to OFF by default.

V . MAINTENACE

5.1 When can't switched ON

- Confirm that the battery has been mounted in its place properly.
- Separate the battery from the equipment to ensure that the contact plane not to be wetted or covered with the dust.

If the contact plane between battery and main body is wetted or covered with the dust, clean and dry it with a piece of cloth.

- Ensure whether battery has been discharged completely.

Secondary battery could be charged through the battery charger.

Primary Battery should be purchased from authorized agency due to charging is impossible.

- Ensure that the knob of power On/Off & Volume Control has been turned correctly.
- Contact manufacturer or its authorized dealer for service.

5.2 When other problems occurred

In case of other problem happen to occur, please contact SRC Co., Ltd. or its authorized dealer for requesting the repair.

This equipment was designed so to have watertight structure and to be enduring against an impact. Therefore, if it is assembled or disassembled by unskilled operator, the watertight and impact problem can occur.



If the equipment has been disassembled by unauthorized personal, it can't be applied to the guarantee service.

In the following cases we would appreciate for the notification of specific defects.

- LCD Damage
- Can not transmit even pressing the PTT switch
- Can not receive
- Problems with Knob

VI. SECONTARY BATTERY & CHARGER

6.1 SECONDARY BATTERY

- 1) The battery used to GMDSS TWO-WAY series (CTW100) is fast charging battery with stability and high-reliability.
- 2) The battery should be fully charged before using for best capacity and safe operation.
- 3) Don't charge by other charger because the battery is designed to use only dedicative charger of manufacturer.
- 4) If the battery is slotted with main body, it should be charged with power-off condition.
- 5) Don't make the battery to be short-circuit.
- 6) If the battery terminal contacts conductor or metal, the material can be damaged and injury the human body. Attention Required.

6.2 CHARGER

- 1) Points to notice as charger using
 - A) If charger is received any shock or is submerged under water, don't charge and take the charger to place where you bought it.
 - B) DC Adaptor should be the standardized goods appointed by manufacturer

C) If charger takes any problems, don't disassembly and take the charger to the place where you bought it.

2) Charger

A) Input voltage: **DC 12V/1A Adaptor**

B) Adapted battery: **Li-ion 2200mA**

C) Charging time: **Around 160 minutes**

D) Operating temperature: **0℃ ~ +40℃**

E) Charging current: **850mA (± 10%)**

3) How to use Fast Charger

DC Adaptor is connected normative AC power supply. Output interface of DC Adaptor is connected input interface of charger.

If you slotted battery in charger, the battery is charged.

*** Charger LED means**

Red LED	charging
Green LED	charged
Yellow LED	charging waiting or battery overheating
Red LED is blinked	battery malfunction

☞ In case, simultaneously batteries are slotted in both slots(Front, Back).

- Front battery is charged and if front battery is charged full, back battery is charged.

☞ In case, batteries are fully discharged, charger can be get into Pre-Charge Mode, and LED blinks with red light.

- If you leave battery pack to be charged for ten minutes, battery pack will be returned to normal voltage. Then release the battery pack from the charger and put it back. The charger enters into Fast-Charge Mode, and charger will stop to blink red light.

- Warranty -

Two-way Radio telephone CTW100 is warranted for a period of twelve months for defects proven to have been caused by faulty materials or workmanship. The reason of a malfunction, however, is caused by any other matters such as delivery, installation, or misuse by end user, the free warranty will be exceptional.

The period of warranty starts from the date of purchase.

If there was any malfunction or false operation of the equipment, we would recommend you to try to find out reasons and solutions according to this manual. Except that you shall contact supplier, agent, or manufacturer to get an appropriate indication for a problem. In the event of that if end user took any action by own and made any damage on the equipment, the manufacturer does not have any responsibility.

N.B. : The time that equipment takes to transmit at manufacturer does not to be included in warranty period.

In a case of service needed, please contact a supplier, an agent, or a manufacturer.

Supplier	In Charger	Contact No.
Supplier	In Charger	Contact No.



SRC Co., Ltd.

5F Deado B/D, 65-23,
Namhang Dong 2Ga, Young Do,
Busan, Korea

TEL : +82 51 412 6197, 6198

FAX : +82 51 412 6199

www.oksrc.com